

Toilet Paper Tube Flower Instructions

There are so many object that we use in our daily lives that end up in the trash can.

It is important to recycle what we can. It is also important to repurpose materials in fun and useful ways.

FLOWER MATERIALS: Scissors, two toilet paper tubes per child, produce netting, staplers and colored pencils or crayons. Instructor will need plastic straws (recycled hopefully), and a needle and thread to string the final flowers. Green paper for leaves. Cut one leaf for each child. They will write their thought on repurposing on these leaves.

Outer flower

1. Cut measuring tape out at bottom of the page. Use this to measure 1 3/4" at one end of a tube and mark in several spots.

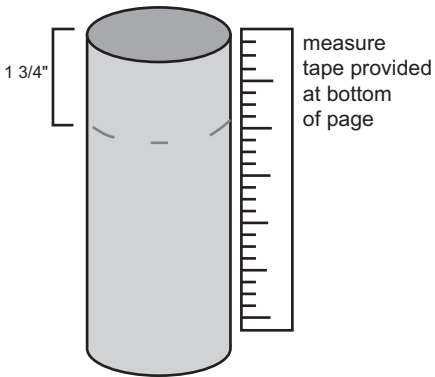

2. Draw a line around the tube connecting the marks. Around the other edge of tube, mark a line at every one inch distance using the measuring tape.

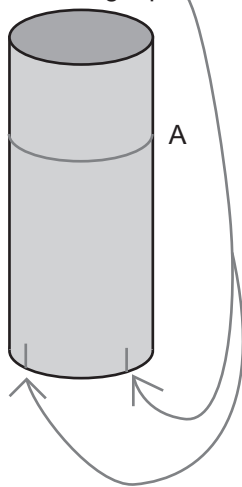

3. Draw lines from these marks straight up to line "A".

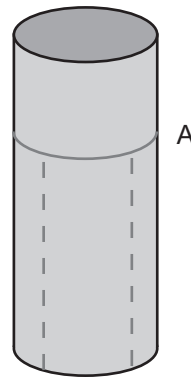

4. Create the five petals by cutting long lines up to line "A".

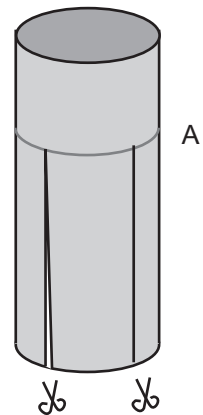

5. Spread apart petals.

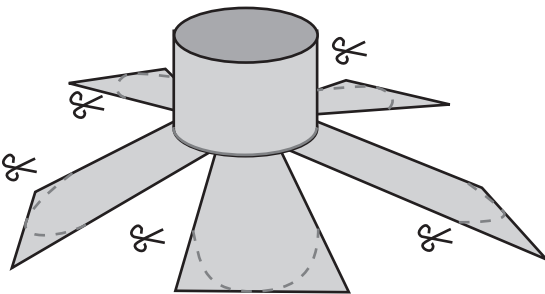

6. Cut rounded petal edges.

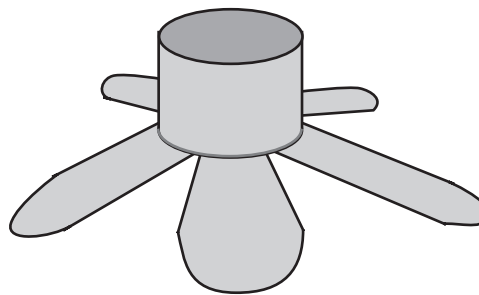

7. Turn over and color tips of petals with crayons or pencils.

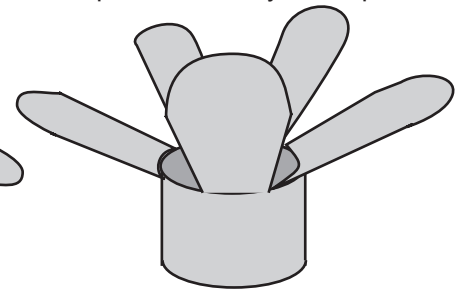

Copyright Corinne Takara 2009 www.okadadesign.com

Inner flower

1. Cut a second tube the same as above up to step 5.

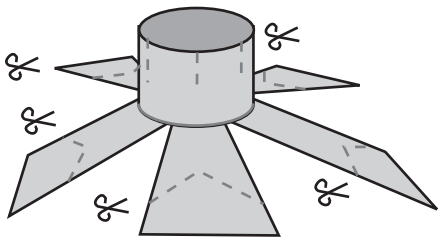

1. Cut petal tips as shown below. Snip tube on other end in a few places.

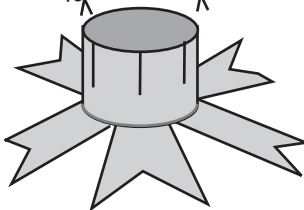

3. Insert inner flower into middle of outer flower.

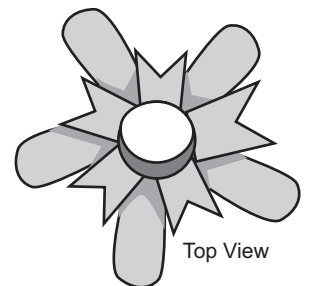
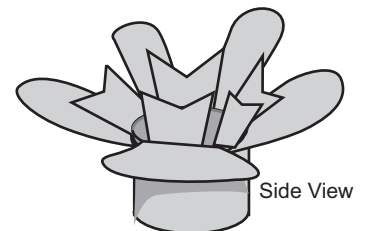
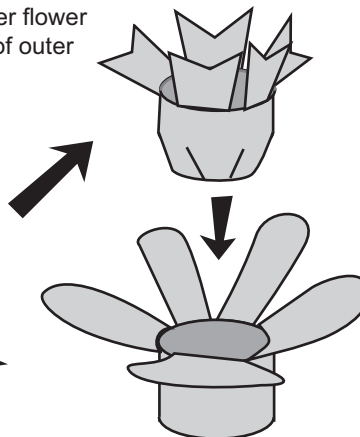

Measuring tape

